



2017-2022 2.5" (63mm) lift kit installation guide

Professional installation is recommended

FOR OFF-ROAD USE ONLY!

IMPORTANT!

Lifting and modifying the suspension on your vehicle may result in drive line vibrations, damaged bushings, erratic handling characteristics, and shortened suspension component life. HRG Offroad recommends the following:

- Checking and/or replacing worn drive axles with new parts, not remanufactured.
- Checking and/or replacing all worn factory rubber bushings with urethane bushings, such as Prothane.
- Checking and/or replacing worn shock absorbers and bump stops.
- Performing a 4 wheel alignment after working on suspension components.

Lift kits may not be legal for use on public highways in your area. Please check local laws before installing!!

WARNING!

Lifted vehicles are more prone to rolling over.

Some HRG Offroad products are designed to improve off-road capabilities. Modifying the suspension of your vehicle may result in handling characteristics that are different from a factory equipped vehicle. Extreme care must be used to prevent a rollover or loss of control. Always operate your modified vehicle at a reduced speed to ensure your ability to maintain control under all driving conditions. Driving your vehicle in an unsafe manner may result in serious injury or death. HRG Offroad lift kits are designed and tested to work together. HRG Offroad does not recommend combining this lift kit with any other type of suspension or body lift. Always wear your seat belt.

Recommended tire/wheel sizes:

Stock size: 235/65/17

+0.5" larger tire: 245/65/17

+1.5" larger tire: 245/70/17* (May require some minor fender modification)

Stock size: 235/60/18

+0.5" larger tire 245/60/18

+1" larger tire: 235/65/18

+1.5" larger tire 245/65/18* (May require some minor fender modification)

Stock size: 235/55/19

+0.5" larger tire 245/55/19

+1" larger tire: 235/60/19

+1" larger tire: 255/55/19

****Be sure to check fitment prior to installation! These sizes are only suggestions. HRG is not responsible for improperly fitted wheels/tires***

Included in the kit:

2 2.5" front spacers 5222
2 1.5" rear spacers 5225
2 1.5" rear shock spacers
2 Sway bar end links for lifted applications
6 M10 nuts (front spacers)
3 M14x100 bolts (engine mount)
3 M12x80 bolts (transmission mount)
2 M6x40 bolts (intercooler pipe)
8 M8x40 bolts (rear subframe brackets)
6 M14x120 bolts (front subframe)
2 M14x160 bolts (rear subframe)
2 M14x150 bolts (rear subframe)
2 M14x70 bolts (front lower arm)
2 M10x50 bolts (carrier bearing)
4 M14x90 bolts (trailing arms)
4 2.75x1 M14 spacers (rear subframe)
6 2.75x1 M14 spacers (front subframe)
3 1.25x1 M14 spacers (engine mount)
4 1.25x1 M14 spacers (trailing arms)
3 1.25x1 M12 spacers (transmission mount)
2 1x1 M10 spacers (carrier bearing)
8 0.75x1 M8 spacers (rear subframe brackets)
4 M8x60 bolts (rear shocks)
2 0.75x0.5 M6 spacers (intercooler pipe)
1 1" foam seal
2 extended exhaust hangers

Skill Level: Moderate.

Installation time: Approximately 5-6 hours

FRONT INSTALLATION:

Step 1. Disconnect and remove the battery.

Step 2. Remove battery tray to allow access to the transmission mount.

Step 3. Unplug intake air temp sensor and remove OEM air box.

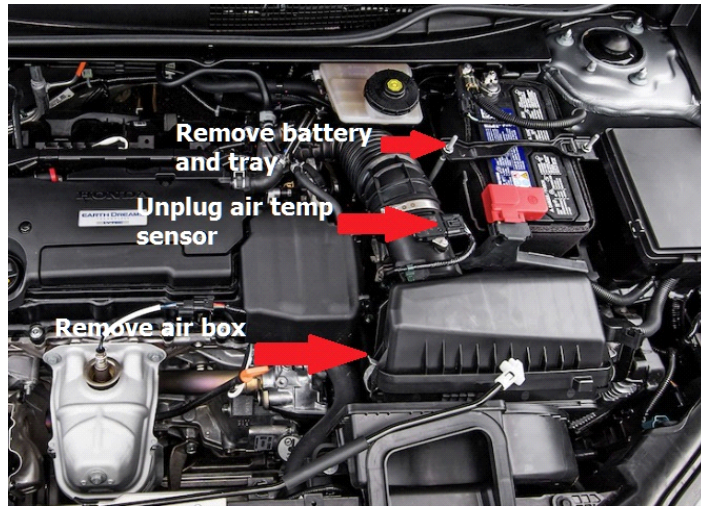

Step 4. Lift vehicle and support with jack stands.

Step 5. Remove lower plastic splash guard under front valance to gain access to front main subframe bolts. Take care not to break plastic retainer clips. Save hardware for re-installation.

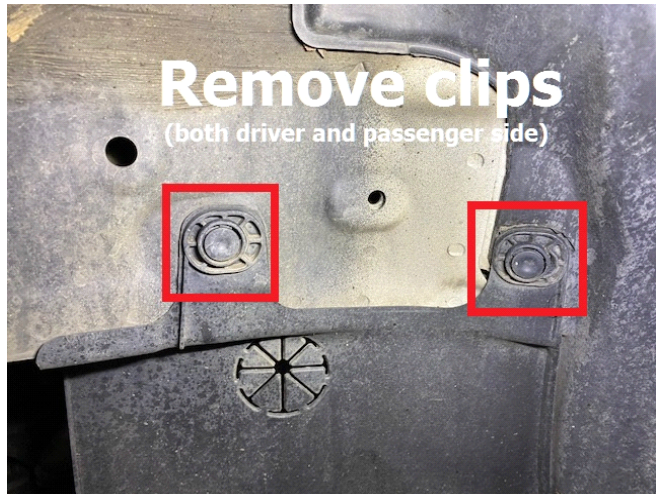
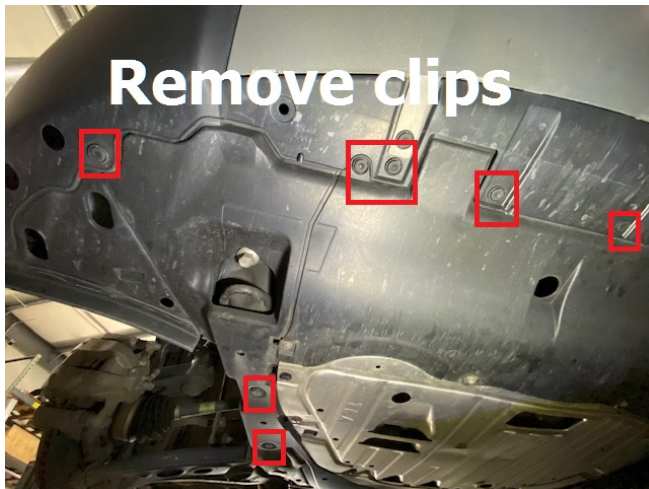

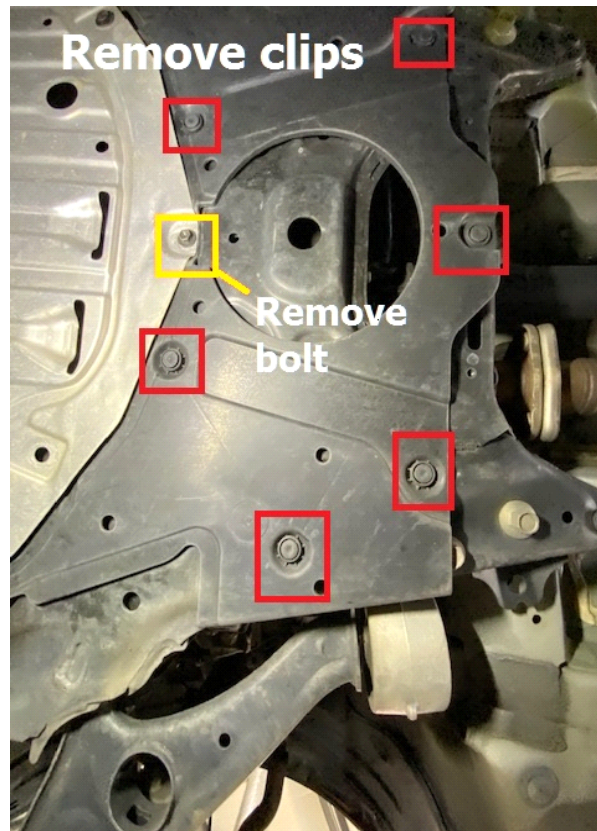

Step 5. Support engine with floor jack or screw jack, take care not to dent oil pan.

Step 6. Remove M12x50 and M12 studs from transmission case (this can be done by threading 2 nuts onto the stud and tightening them against each other, then backing the stud out). Alternatively, thread 1 nut onto the stud, tack weld it in place, then back the stud out. These studs will be replaced with bolts in a later step.

**2017-2022 HONDA CR-V
TRANSMISSION MOUNT
DIAGRAM
(C)HRG OFFROAD 2022**

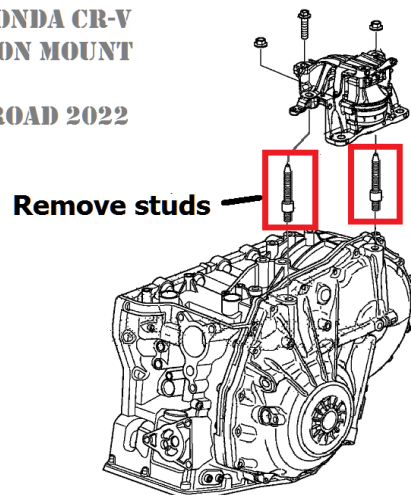

Step 7. Remove M14 nut and M14x70 bolts holding the engine bracket to the body and the engine. Remove passenger side engine bracket.

Step 8. Remove M14 stud from engine bracket (this can be done by threading 2 nuts onto the stud and tightening them against each other, then backing the stud out. Alternatively, thread 1 nut onto the stud, tack weld it in place, then back the stud out.

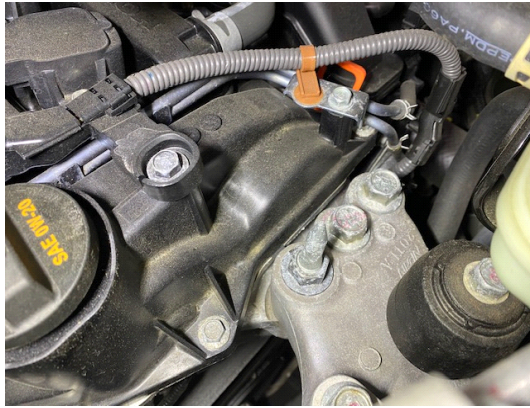

Step 9. Remove subframe bolts shown in photos below (both driver and passenger side)

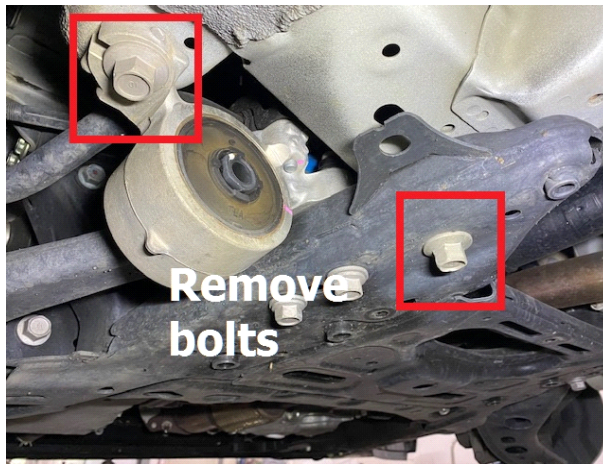
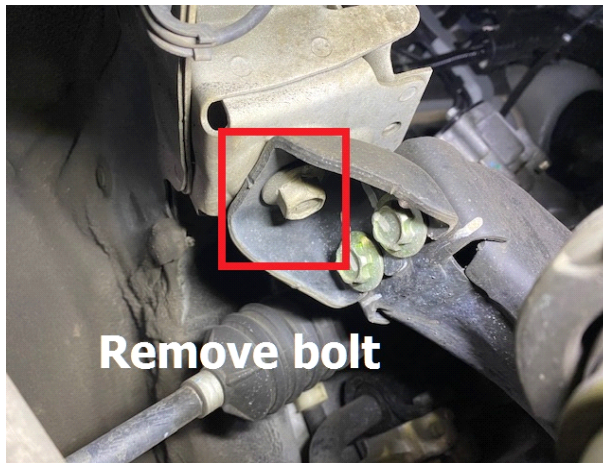

Step 10. Loosen but **do not remove** front-most 2 bolts in subframe (to maintain alignment).

Step 11. Lower entire engine/ subframe assembly 1 inch, allowing placement of 2.75x1 M14 spacers between subframe and body (as shown in photos below)

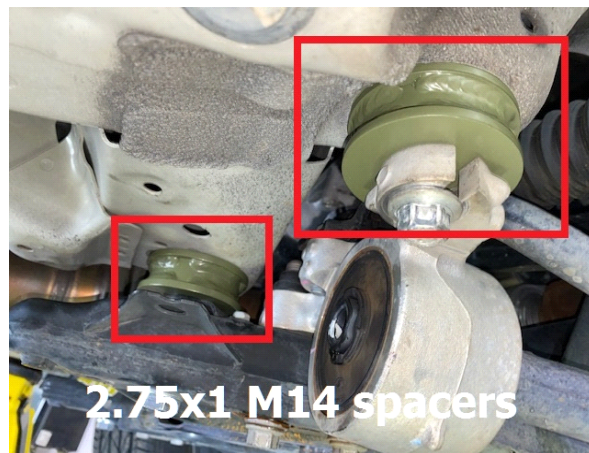
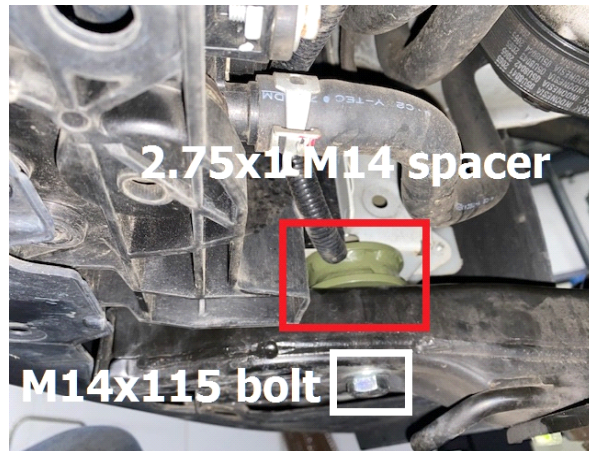
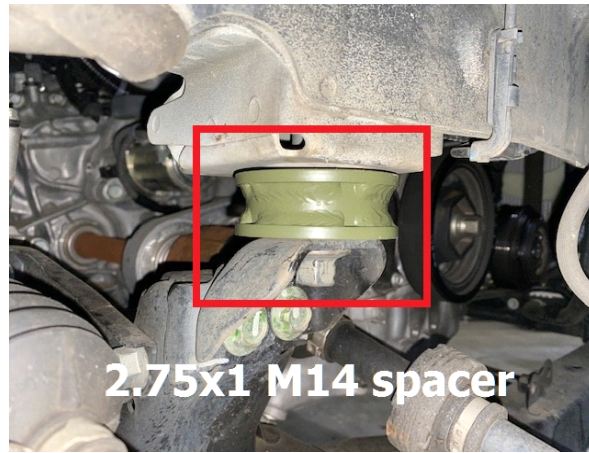

Step 12. Install M14x115 bolts in place of OEM bolts to secure subframe in place

Step 13. Remove front most 2 subframe bolts, place 2.75x1 M14 spacers, secure with M14x115 bolts.

Step 14. Use the floor jack to adjust the height of the engine/transmission so that 1.25x1 M12 spacers will fit between transmission case and transmission bracket.

Step 15. Install 3 M12x80 bolts into transmission bracket (see diagram)

**2017-2022 HONDA CR-V
TRANSMISSION MOUNT
DIAGRAM
(C)HRG OFFROAD 2022**

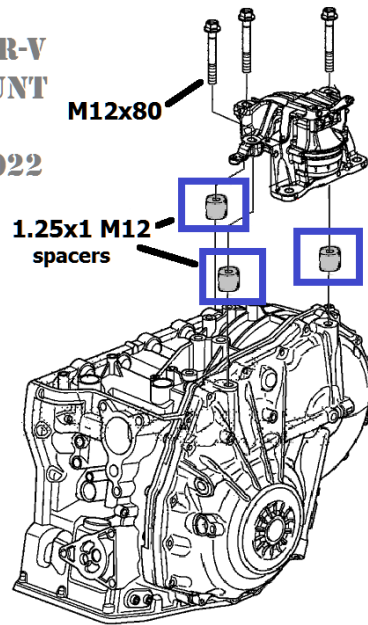

Step 16. Place 3 1.25x1 M14 spacers between engine mount and engine bracket.

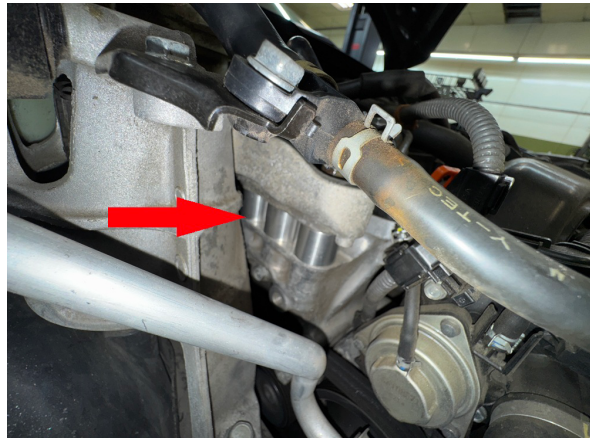

Step 17. Reinstall engine bracket using M14x100 bolts. (see diagram)

**2017-2022 HONDA CR-V
ENGINE MOUNT
DIAGRAM
(C)HRG OFFROAD 2022**

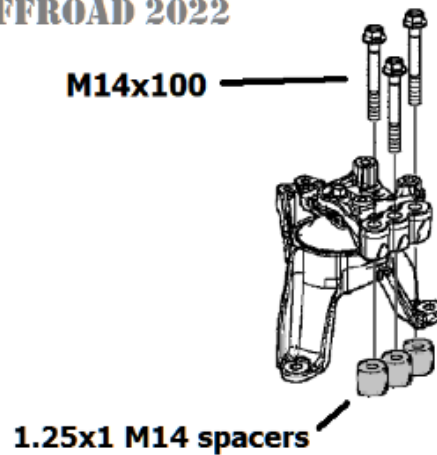

Step 18. **(1.8 Turbo engine only)** Remove 2 bolts holding upper charge pipe to transmission. (see photo)

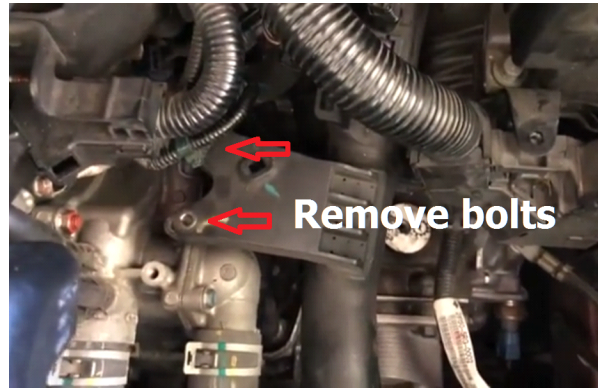

Step 18a. **(1.8 Turbo engine only)** Install 2 aluminum spacers between charge pipe and transmission. (see diagram)

**2017-21 CR-V INTERCOOLER
PIPE DIAGRAM
(C) HRGOFFROAD 2022**

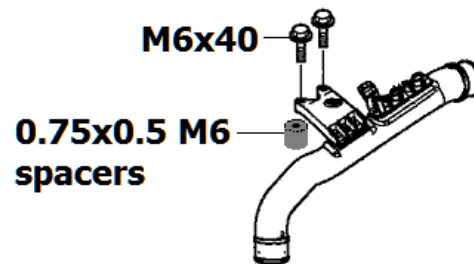

Step 19. Trim plastic splash shield as necessary to fit with lowered subframe, reinstall using original hardware. It may be necessary to drill new holes to allow the mounting clips to line up.

Step 20. Under driver dash, remove plastic dust cover on steering column to gain access to steering coupler.

Step 21. Using a body saw, trim sheet metal for clearance around steering coupler. *This step can also be done by simply bending the sheet metal back about 1/2 inch around the coupler. Turn steering wheel to verify the coupler has proper clearance.

Step 22. Rotate steering wheel to check for noises. If noise is present, loosen M8 bolts 2 turns on upper and lower steering "U-joint" couplers, turn the wheel lock to lock and then re-tighten. **Do not remove these bolts.** In rare cases, it may be necessary to place shims between the steering column and dash bar. (see diagram below)

**2017-2022 CR-V STEERING COLUMN DIAGRAM
(C)HRG OFFROAD 2022**

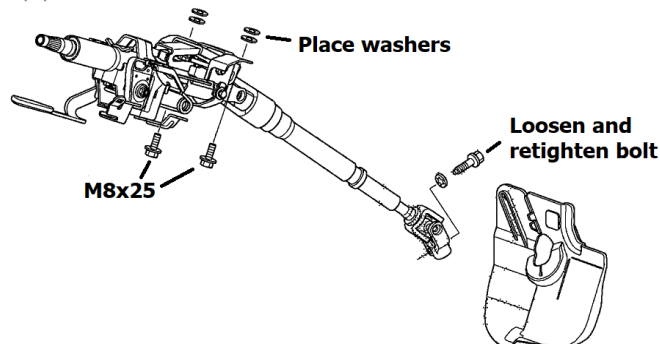

Step 23. Install foam weather seal between steering rack and body.

Step 24. Re-install dust cover on steering column below interior dashboard. Trim if necessary.



Step 25. Remove 2 17mm bolts holding brake caliper to wheel hub, suspend brake caliper to prevent stress on the flexible brake lines.

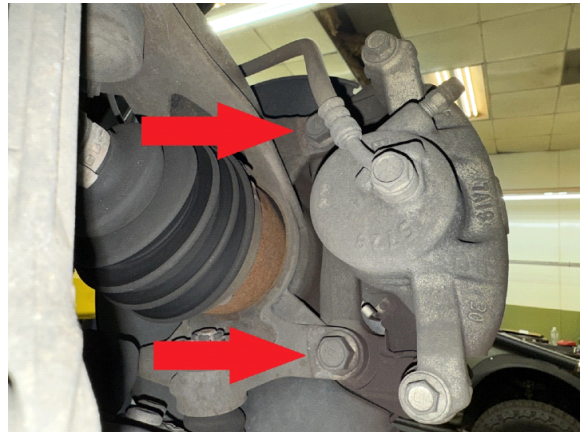

Step 26. Remove brake lines and ABS wiring, remove wheel sensor from knuckle.

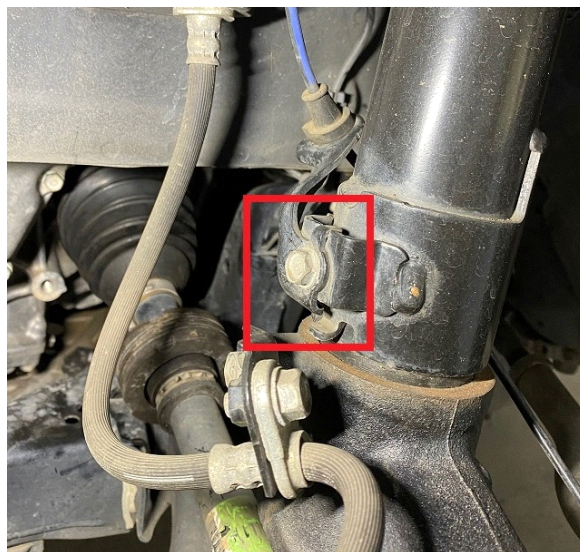

Step 28. Remove sway bar end link.

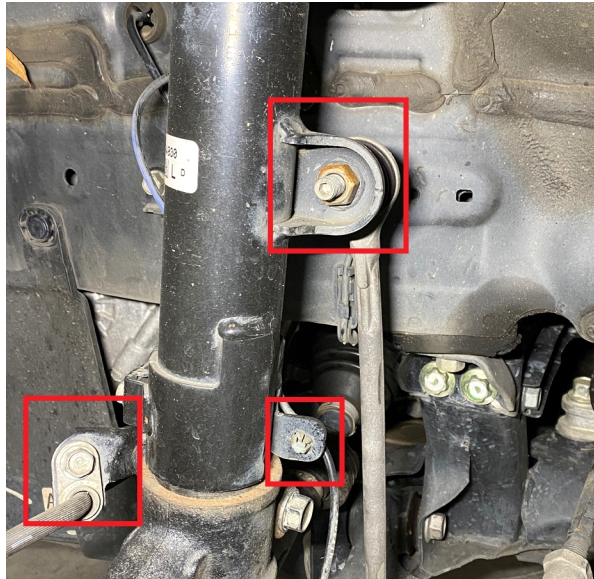

Step 29. Remove axle nut, slide axle out and remove strut, hub and brake rotor assembly.

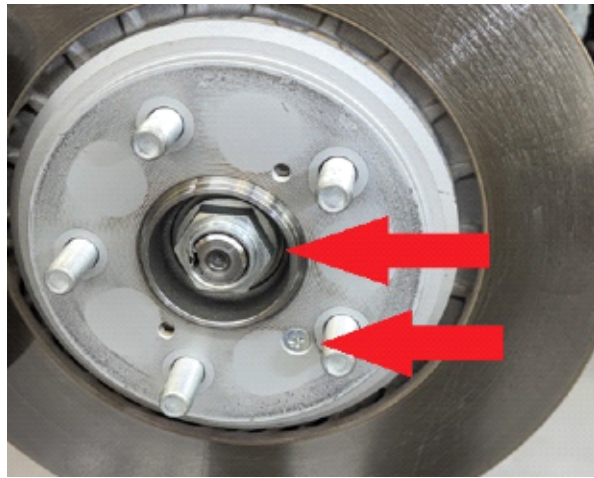

Step 30. Remove 3 17mm nuts holding lower ball joint to hub.

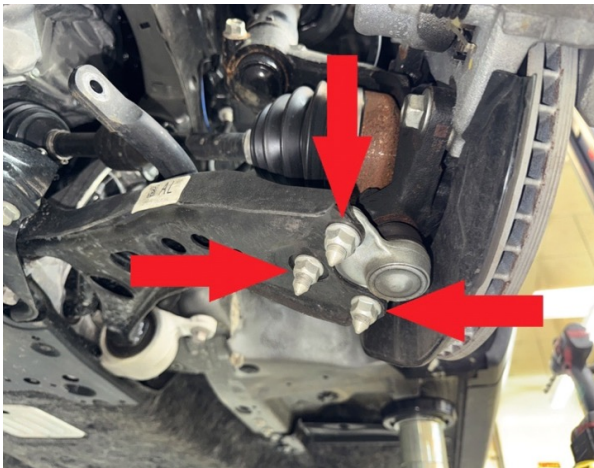

Step 31. Remove nuts from shock tower on driver side. Have a helper remove the strut and knuckle assembly.

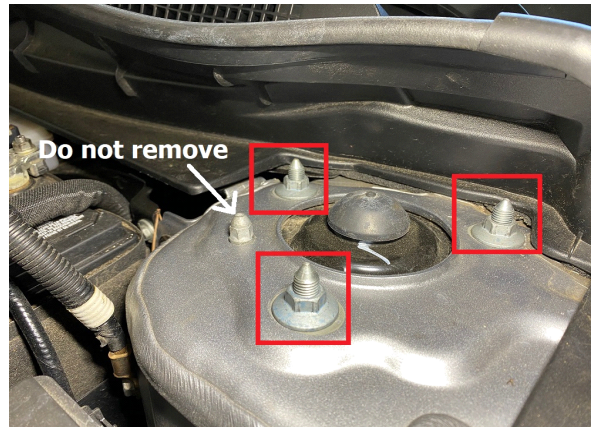

Step 32. Place strut spacer on top of strut and secure with hardware provided in the kit.



Step 33. Spin strut top 180* and slide studs on spacer through original mounting holes in strut tower. Secure strut spacer with OEM hardware. Tighten nuts to 33 ft-lb.

Step 34. Slide axle back into hub assembly and thread nut on to axle shaft. Torque axle nut to 242 ft-lb.

Step 35. Mount strut/spacer combo into shock tower using OEM hardware.

Step 36. Using a large pry bar, line up the lower control arm with the hub assembly and reinstall 3 nuts. Tighten nuts to 74 ft-lb.



Step 37. Reinstall brake rotor and caliper. Tighten caliper bolts to 80 ft-lb.

Step 38. Reinstall tie rod end and castle nut. Do not forget the cotter pin!

Step 39. Install brake line relocation bracket on brake line mount. (see photo)

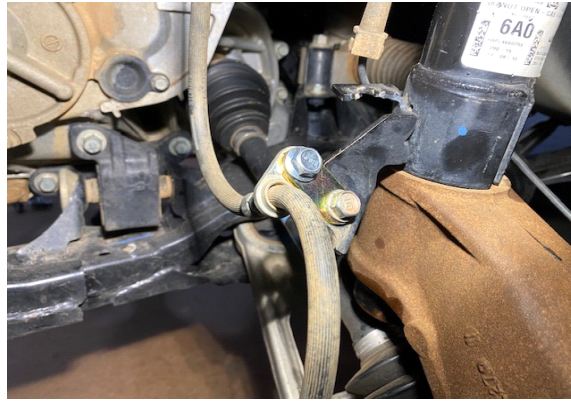

Step 40. Reinstall ABS wire, wheel sensor, and brake line. Tighten brake line mounting bolts to 25 ft-lb.

Step 41. Using a ½ inch drill bit, drill out sway bar and sway bar link mount on strut to allow the larger sway bar end link to fit.



Step 42. Install new sway bar end link. **Note: sway bar link holes will not line up until both sides are lifted.**

Step 43. Double check all bolts.

Step 44. Repeat installation process for passenger side.

Step 45. Attach sway bar links. Torque nuts to 56 ft-lb.

Step 46. Reinstall wheels.

REAR INSTALLATION:

Step 1. Lift vehicle and support with jack stands.

Step 2. Remove wheels.

Step 3. support rear subframe with floor jack or screw jack.

Step 4. Remove 12mm bolts holding subframe stiffener brackets to body. See photos below.

Step 5. Remove main subframe bolt starting with driver side front corner. Temporarily thread in a M14x150 bolt included in the kit. (this will help to maintain rear subframe alignment)

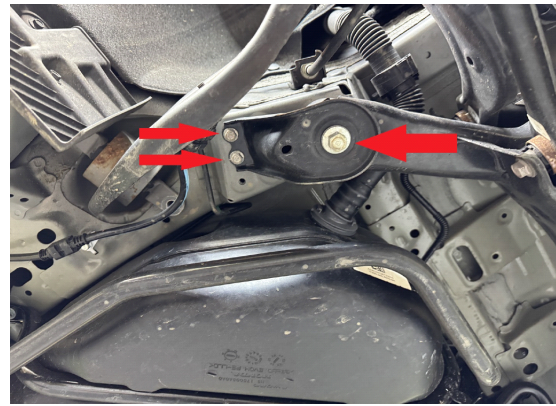
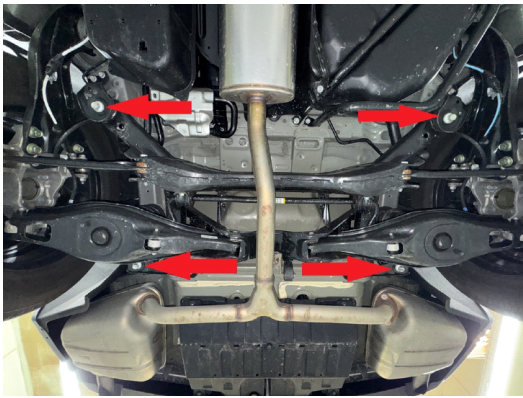

Step 6. Repeat this process on passenger side.

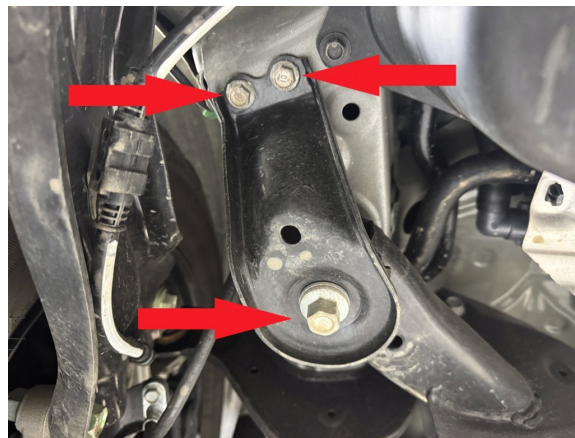

Step 7. Remove driver side rear main subframe bolt. Temporarily thread in a M14x160 bolt included in the kit. (see photos)

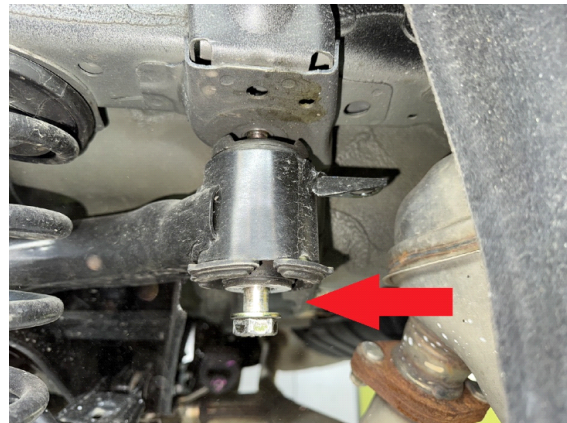
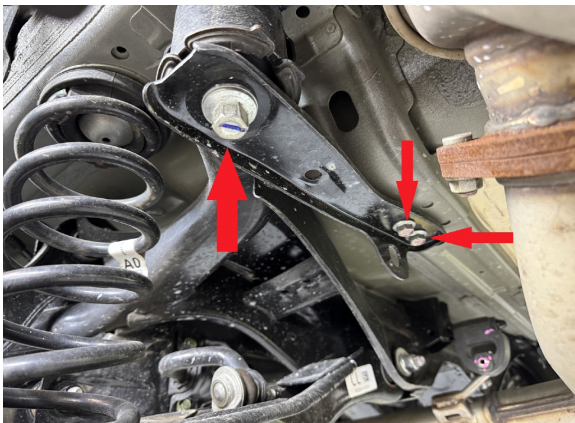

Step 8. Repeat this process on passenger side.

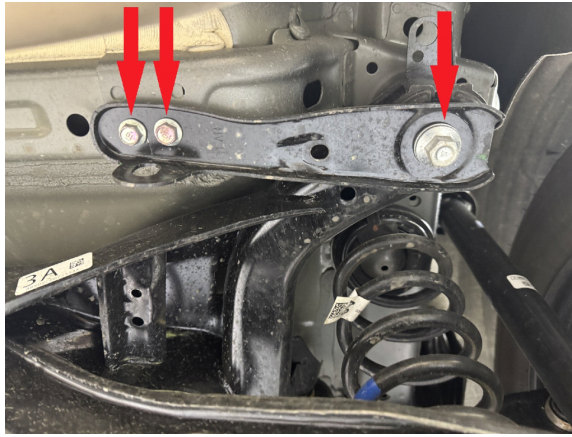

Step 9. Carefully lower subframe approximately 1 inch.

Step 10. Remove M14x150 bolt from driver side front corner and place 2.75x1 M14 spacer between subframe and body. Place 2 0.75x1 M8 spacers between subframe stiffener bracket and body. Reinstall M14x150 bolt, install 2 M8x40 bolts into stiffener bracket. (see photo) Torque M14 bolts to 110 ft-lb. Torque M8 bolts to 30 ft-lb



Step 11. Repeat this process on all 4 corners of the subframe.



Step 12. Remove 2 bolts holding driver side trailing arm to body.

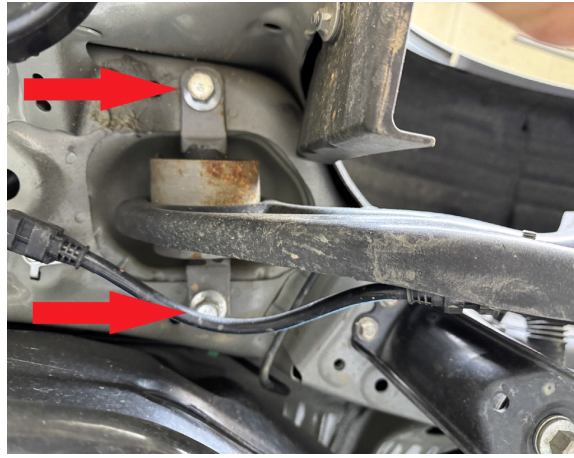

Step 13. Place 1.25x1 M14 spacers between trailing arm and body. Install M14x90 bolts.

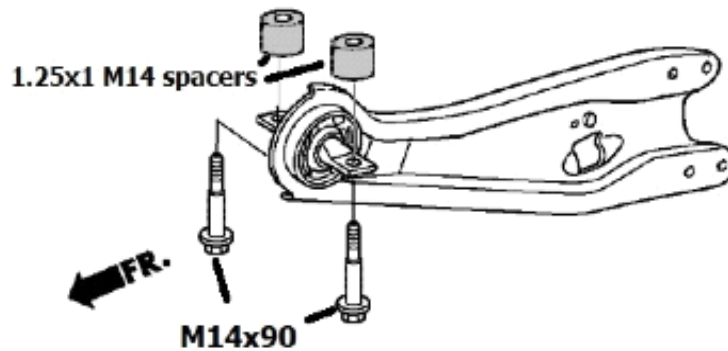

Step 14. Remove 2 12mm bolts holding shock absorber into wheel well.

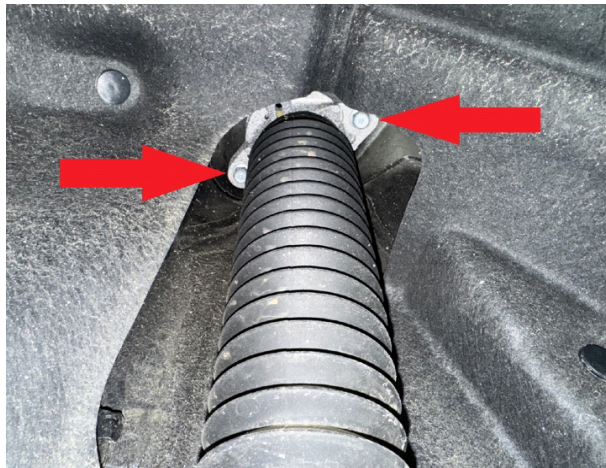

Step 15. Support driver side lower control arm with floor jack or screw jack.

Step 16. Remove bolts holding rear sway bar link and wheel hub to lower control arm on driver side. Loosen, do not remove rear alignment bolt, allowing lower control arm to drop. Carefully release pressure on spring by lowering jack.

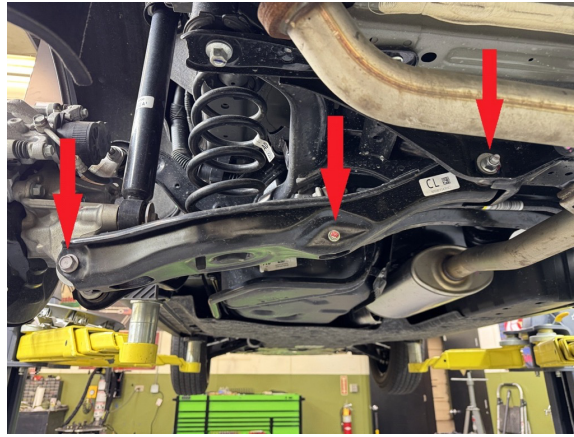

Step 17. Remove spring and place lift spacer on top of rubber isolator as shown.



Step 18. Reinstall spring and spacer. Be sure lower spring coil is rotated properly and fully seated in the lower rubber isolator.



Step 19. Place rear shock spacer between rear shock and body, install M8x60 bolts. torque bolts to 30 ft-lb



Step 20. Use jack to compress the spring and raise the lower control arm back into place.

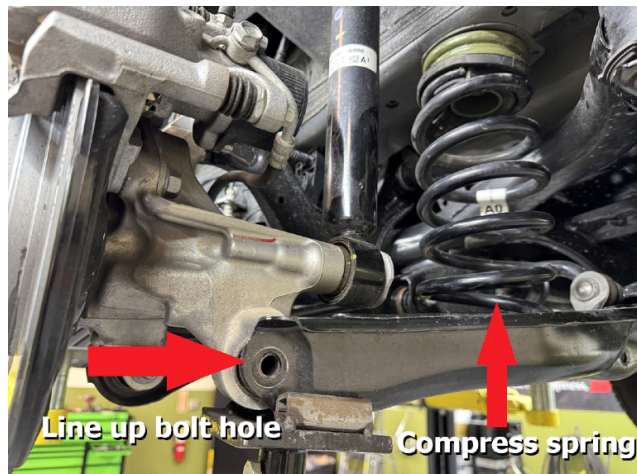

Step 21. Reinstall bolt holding lower control arm to wheel hub.

Step 22. Reinstall sway bar link bolt and tighten alignment bolt.

Step 23. Repeat installation process for passenger side.

2WD MODELS SKIP TO STEP 28.

Step 24. **4WD MODELS ONLY:** Remove 2 bolts holding center driveshaft carrier bearing to body.

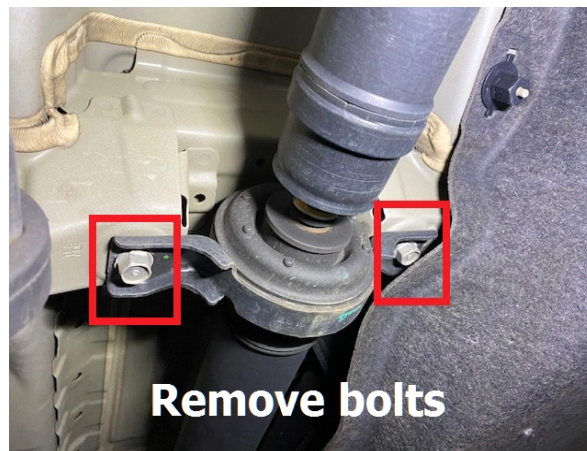

Step 25. Carefully lower driveshaft 1 inch and place 1x1 M10 spacers between driveshaft carrier bearing and body. Secure with M10x50 bolts. (refer to diagram on back page)

Step 26. Remove 2 bolts holding driveshaft protector to body. (see photo)



Step 27. Install 2 0.75x1 M8 spacers between protector and body. Secure with M8x40 bolts.

Step 28. Double check all bolts.

Step 29. Reinstall wheels.

Step 30. Get a professional 4-wheel alignment.

Step 31. Find some trails!



Note: Installing a lift kit will change the suspension geometry and will require a 4 wheel alignment.

Warning: Failure to follow the procedures in these installation instructions may result in unsafe handling characteristics, damage to vehicle, or loss of control.

For tech support, please call 1-844- HRG LIFT (474-5438) from 8-4:30 PM EST

This product is intended for off-road use only!!

Copyright HRG Offroad 2025

**2017-2022 HONDA CR-V SUBFRAME DIAGRAM
(C) HRG OFFROAD 2022**

